

ASSEMBLY INSTRUCTION

ADVANCE

Single Rail Clothes Rack

ITEM CODE 75106/75107

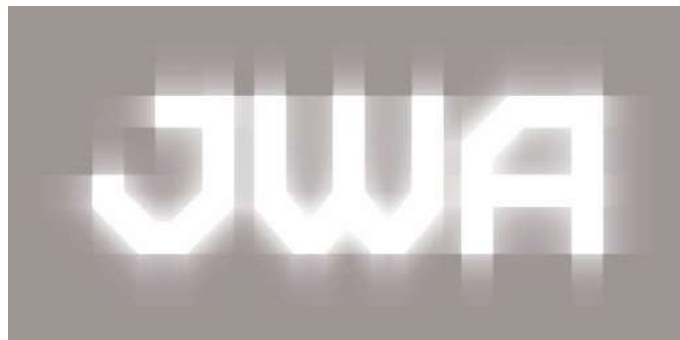
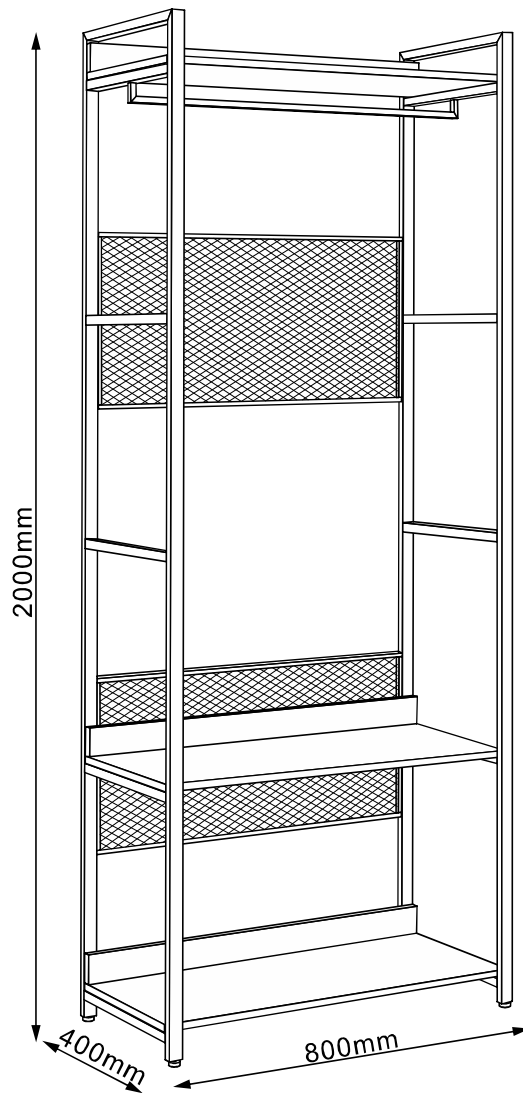



Imported by JWA Furniture Pty Ltd, Qld, Brisbane Australia.
For any assistance with assembly or for missing parts please refer to your receipt

PRE-ASSEMBLY PREPARATION

Before you start:

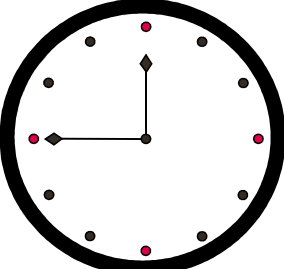
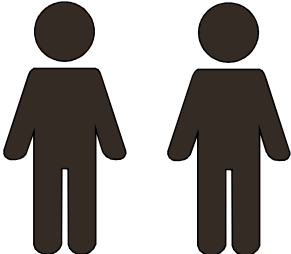
1. Choose a clean, level, spacious assembly area. Avoid hard surfaces that may damage the product
2. Take care when lifting. Product should be assembled as near as possible to the point of use
3. Ensure that you have all required contents for complete assembly
4. Always read the assembly instructions carefully before beginning assembly.
5. Keep all hardware parts and packaging out of reach of small children.
6. Do not over tighten the screws and bolts as this may damage the threads
7. Assembly is to be carried out by a competent adult(s) ONLY
8. During assembly, children should be kept away from the product due to possible risk to injury.
9. Do not use this item if any components are missing or damaged.
10. Please keep the instructions for future reference.

		
<p>Allow 45min</p>	<p>For 2 person</p>	<p>Additional tools required</p>



TIPPING WARNING





Serious or fatal injuries may occur from furniture toppling over. To help avoid this please follow the below recommendations;

- Install the provided "Tipping Kit" as per the instructions
- Never allow children to climb on or hang off of any part of this product
- Unless specifically designed to accommodate, do not set TVs or other heavy objects on top of this product

IF this product has drawers:

- Place the heaviest items in lowest drawers
- Do not open more than 1 drawer at a time as this may cause the product to become unbalanced
- Do not tamper with or remove any drawer interlocking/running system

Note: The use of the provided "Tipping Kit" may reduce but not necessarily eliminate the risk of furniture toppling over. Please use this product with caution.

This is a permanent label. Do not attempt to remove!

PARTS LIST

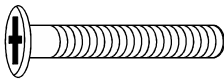
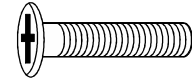
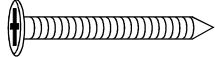
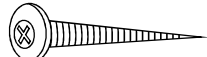
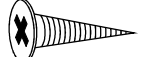
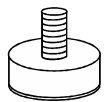
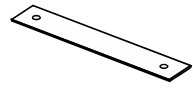
<p>A</p>  <p>M6X40 mm 8pcs</p>	<p>B</p>  <p>M6X30 mm 14pcs</p>	<p>C</p>  <p>ST5X50mm 6pcs</p>	<p>D</p>  <p>ST4X25mm 2pcs</p>	<p>E</p>  <p>ST3.5X14mm 2pcs</p>
<p>F</p>  <p>M8X20X10mm 4pcs</p>	<p>G</p>  <p>2pcs</p>			

1	Top panel
2	Middle panel
3	Back panel
P1	Metal frame
P2	Coat hanger
P3	Back mesh

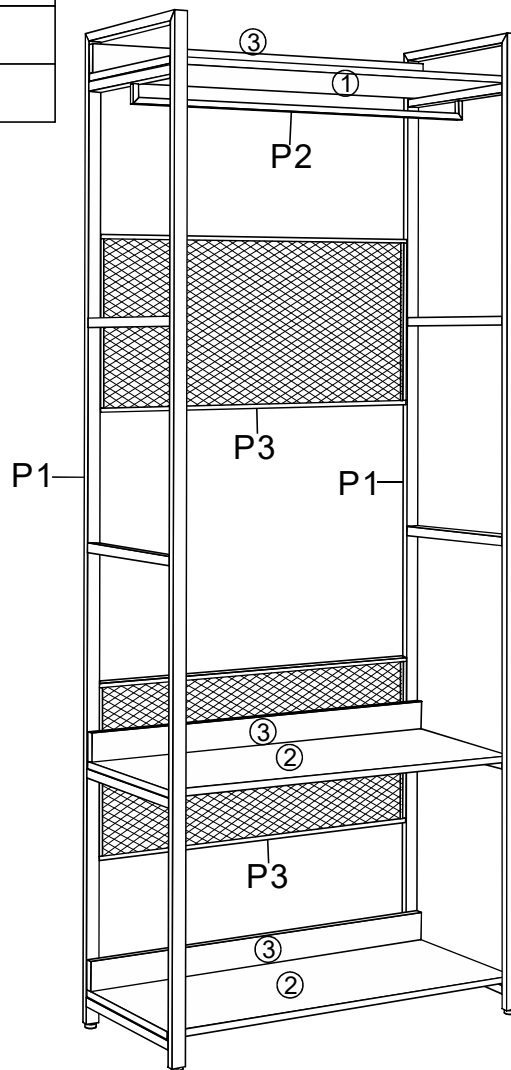

STEP 1:

1. Insert part F into the corresponding hole at the bottom of metal frame P1;
Then attach coat hanger P2 to metal frame P1 with part B.

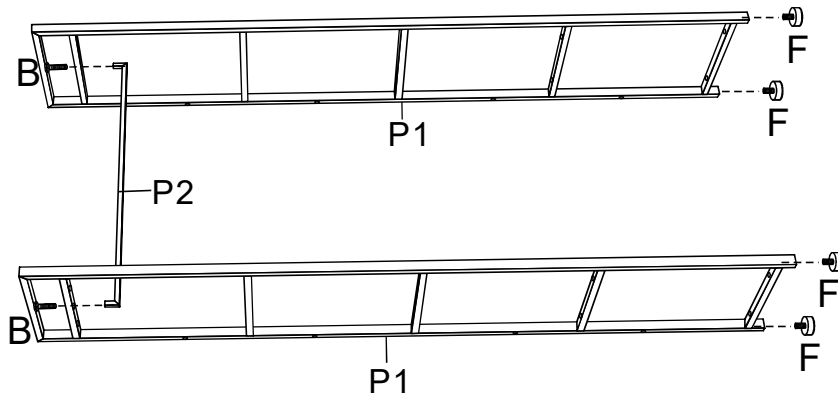

STEP 2:

1. Attach back mesh P3 to metal frame P1 with part A.

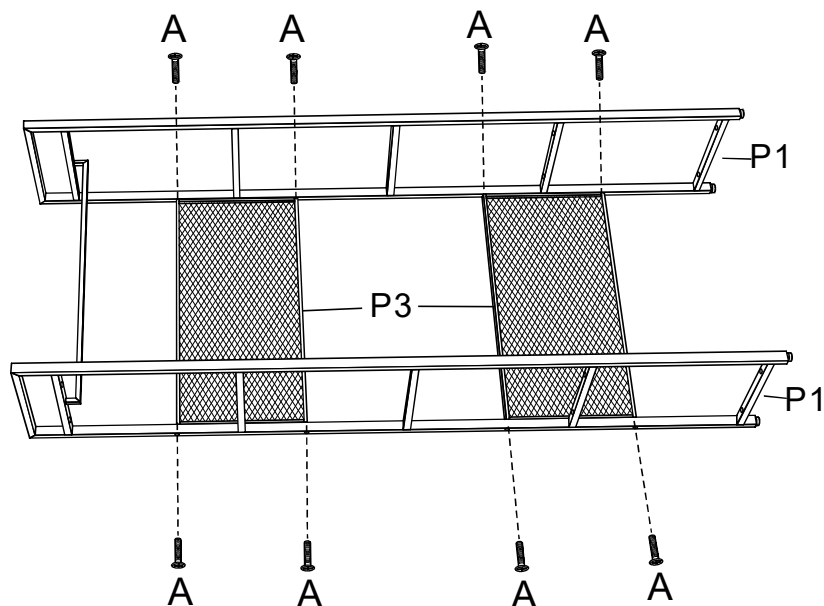

STEP 5:

Install Tip Kit

1. Attach safety strap G to panel 1 with part E.
2. Then attached the other side to the wall with part D. Follow this step to attach another safety strap.

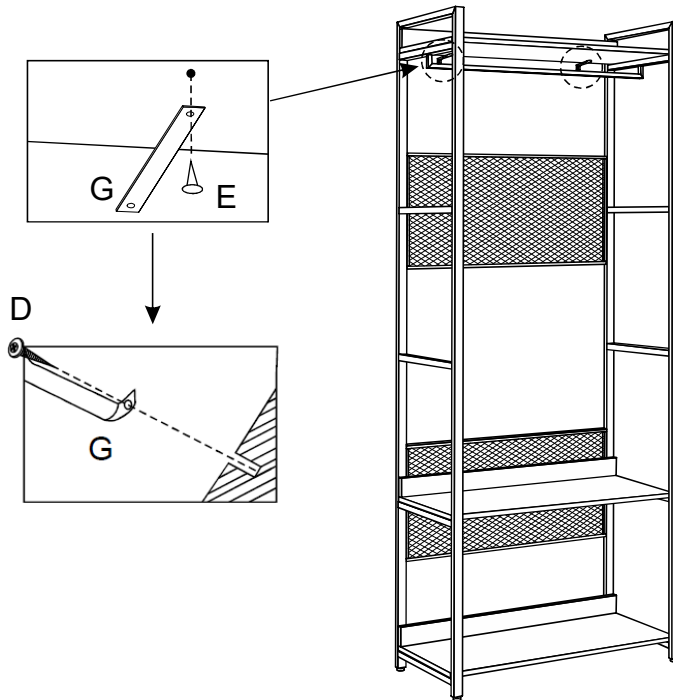

STEP 6:

Assembly complete!

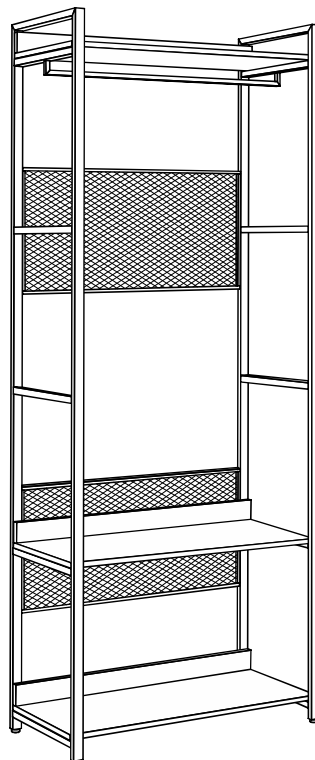

To protect your furniture, we suggest the following:

- Avoid placing your furniture in direct sunlight.
- Do not place furniture directly under windows.
- Do not place sharp materials (knife, fork, etc.) directly onto your furniture as sharp material may scrape and damage the finish.
- Do not place material with high temperature directly onto the surface of your furniture.
- Clean up spills quickly. Water left over a prolonged period of time may cause damage. Alcohol, perfume, nail polishes, aftershave and some medication may cause severe finish damage if not cleaned immediately.
- Use a clean, soft, dry, lint free absorbent cloth to clean your furniture. Do not use any detergent as they may contain ingredients that may react and damage the finish.

NOTE: If the above care advise is not adhered to your product warranty may become void